

vidawings
scan friendly

MODULAR SCAN REFERENCE SYSTEM



ACCURATE SCAN SOLUTIONS

- 7 Diameters
- Multiple Connections (\varnothing 3.4-5.4mm)
- Unique Smart Geometry



Designed to improve scan stability, reduce rework and support a cost-efficient digital workflow.



Improved Scan Accuracy

Additional geometric reference points increase scan stability and reduce stitching errors.



Reduced Re-Scanning

More stable scan data reduces errors and repeated scans.

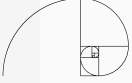

Intelligent Geometry Design



PEEK Material

Provides excellent durability and is fully autoclavable for repeated sterilization cycles.



Better Prosthetic Fit



Cost-Efficient Digital Workflow

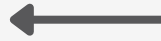
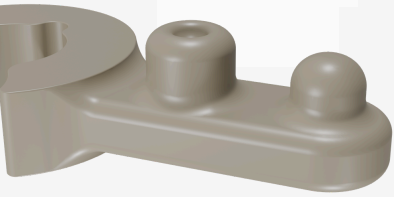



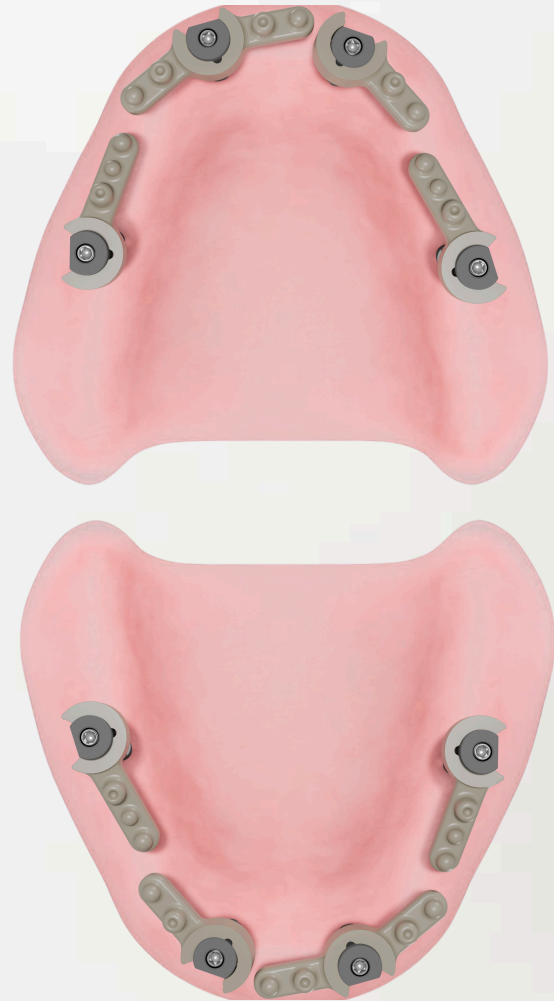
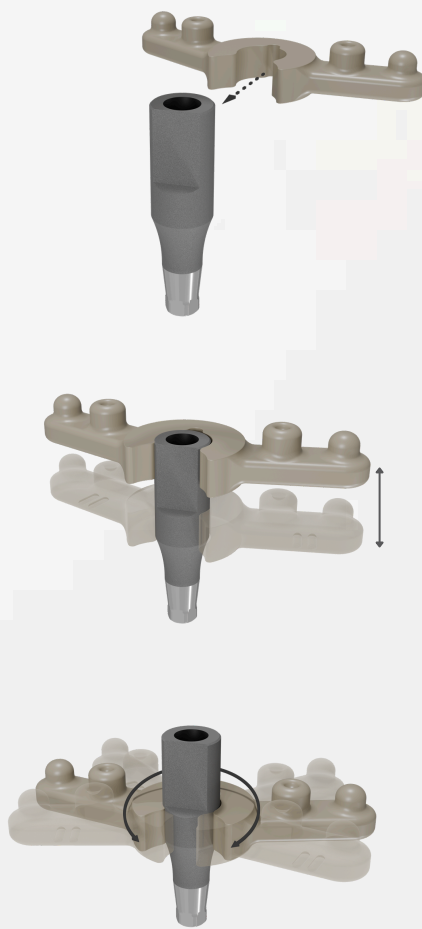



Rounded wing geometry improves scanner visibility, enabling faster data capture and smoother scanning.









Universal Compatibility

choose
your
type

Type I Ø3.4mm	
Type II Ø3.7mm	
Type III Ø4.0mm	
Type IV Ø4.4mm	
Type V Ø4.7mm	
Type VI Ø5.0mm	
Type VII Ø5.4mm	

meet
the
wings



	Bilateral
	Unilateral Short <i>Right</i>
	Unilateral Short <i>Left</i>
	Unilateral Long <i>Right</i>
	Unilateral Long <i>Left</i>
	Angulated <i>Right</i>
	Angulated <i>Left</i>



For individual wings,
please scan the QR code
and visit the website.

